

## SERIE EUROSTAR 60

### CARACTERÍSTICAS:

- Corredera de corte recto.

### SECCIÓN

- Cerco: 60 mm.
- Hoja: 24 mm.
- Acristalamiento Máximo: 15 mm.

### CLASIFICACIÓN DE ENSAYO:

- Permeabilidad al aire: CLASE 3
- Estanqueidad al agua: CLASE 5A
- Resistencia al viento: CLASE C3

### ACABADOS:

- Anodizado.
- Lacado Color.
- Lacado imitación madera.
- Efecta Madera.

### POSIBILIDADES DE APERTURA:

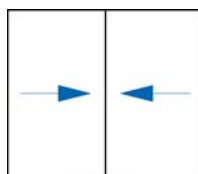

CORREDERA  
2 HOJAS

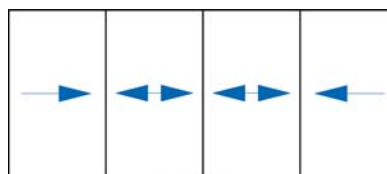

CORREDERA  
4 HOJAS

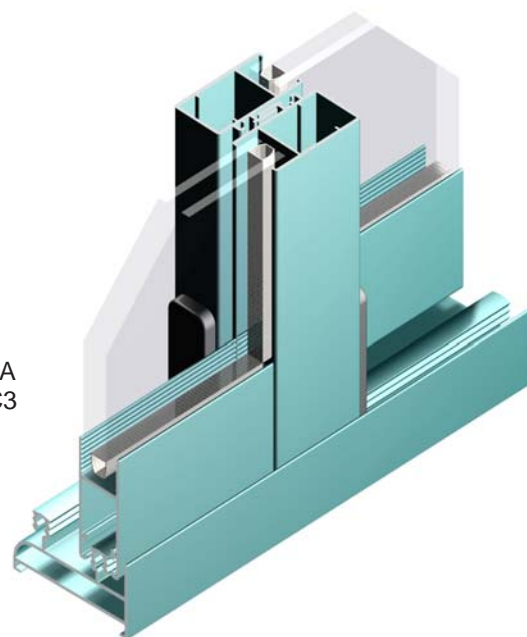

# Serie EUROSTAR 60

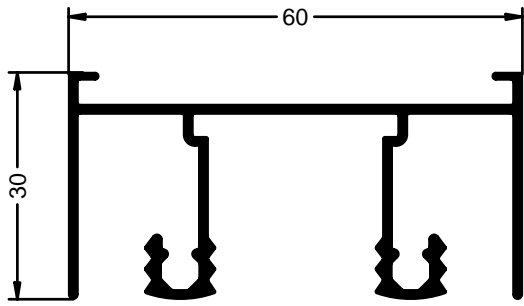

CERCO SUPERIOR

Ref: 6050

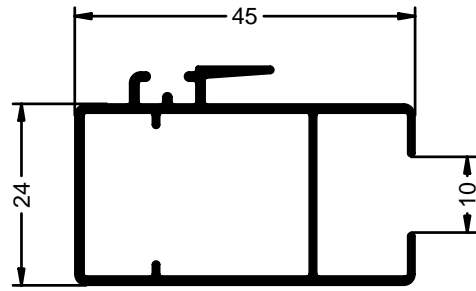

HOJA CENTRAL

Ref: 6054

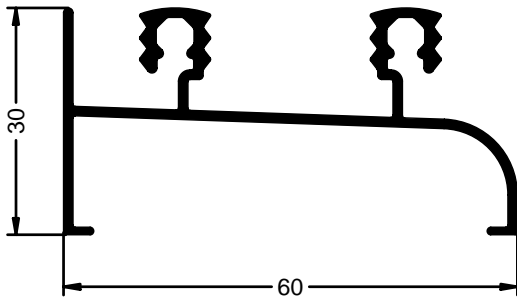

CERCO INFERIOR

Ref: 6051

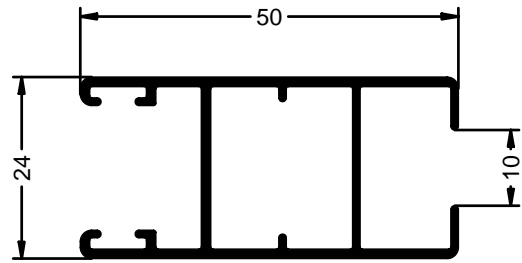

HOJA LATERAL

Ref: 6055

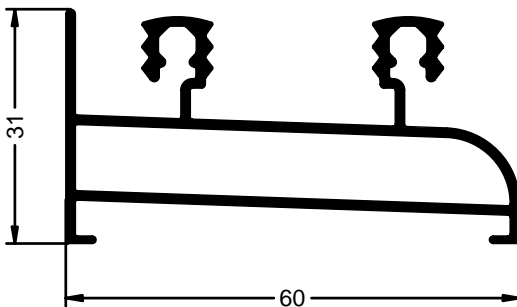

CERCO INFERIOR TUBULAR

Ref: 6052

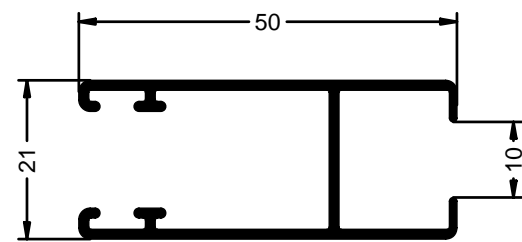

HOJA DE RUEDAS

Ref: 6056

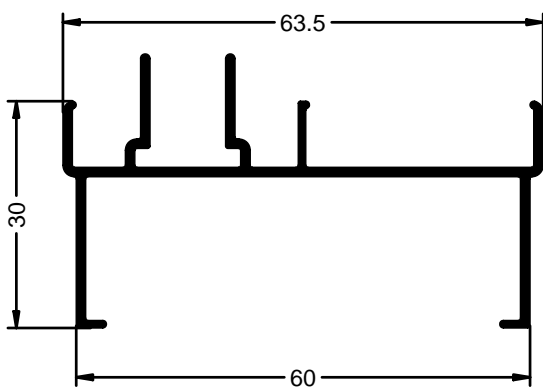

CERCO LATERAL

Ref: 6053

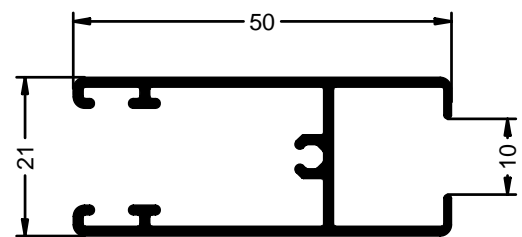

HOJA DE RUEDAS TORNILLO

Ref: 6090

\*

# Serie EUROSTAR 60

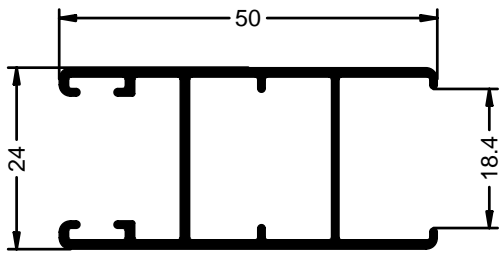

HOJA LATERAL CLIMALIT

Ref: 6058

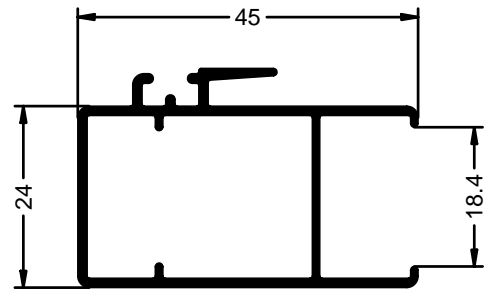

HOJA CENTRAL CLIMALIT

Ref: 6057

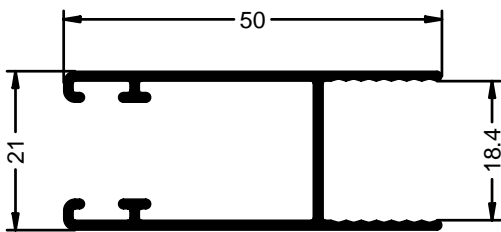

HOJA DE RUEDAS CLIMALIT

Ref: 6059

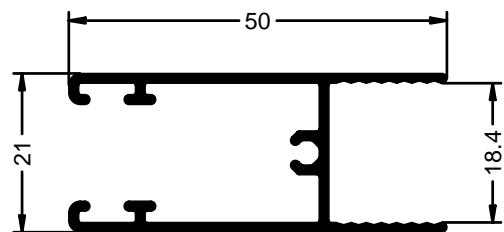

HOJA DE RUEDAS CLIMALIT CON TORNILLO

Ref: 6091

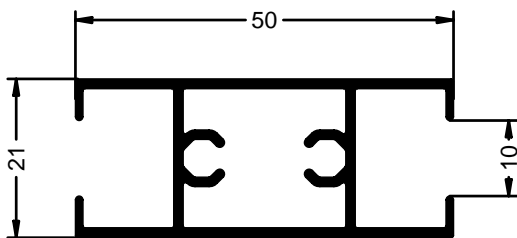

PARTELUNAS

Ref: 6061

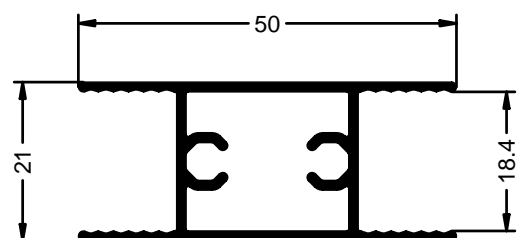

PARTELUNAS CLIMALIT

Ref: 6062

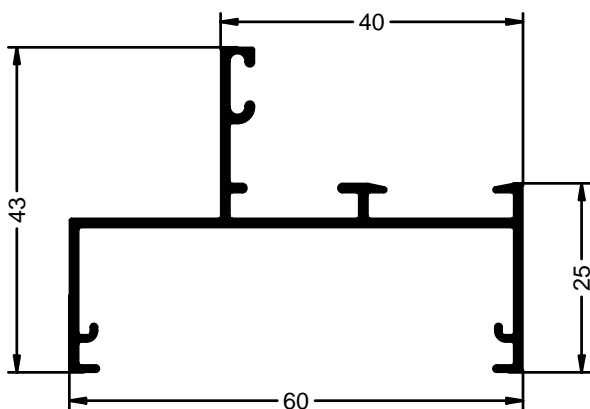

CERCO FIJO

Ref: 6060

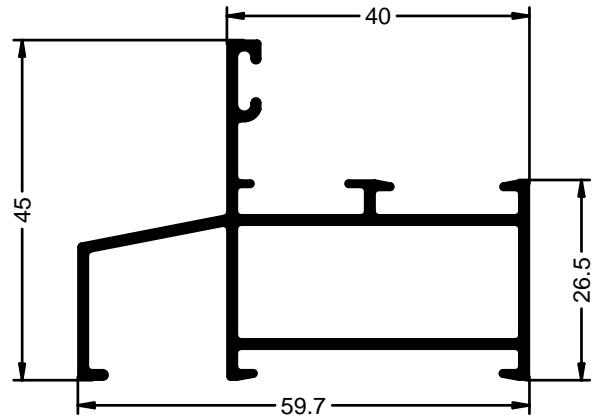

CERCO FIJO

Ref: 6012

# Serie EUROSTAR 60

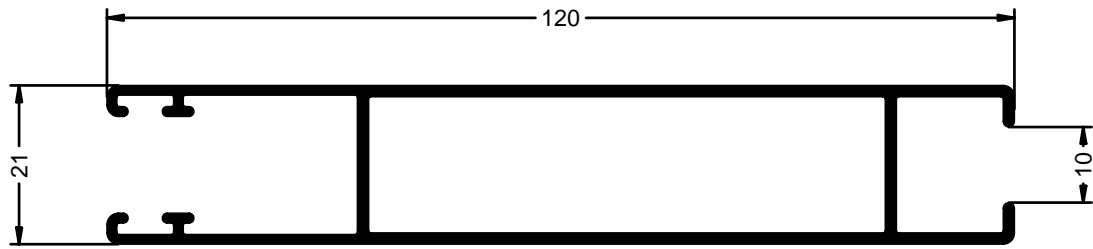

ZÓCALO DE RUEDAS

Ref: 6069

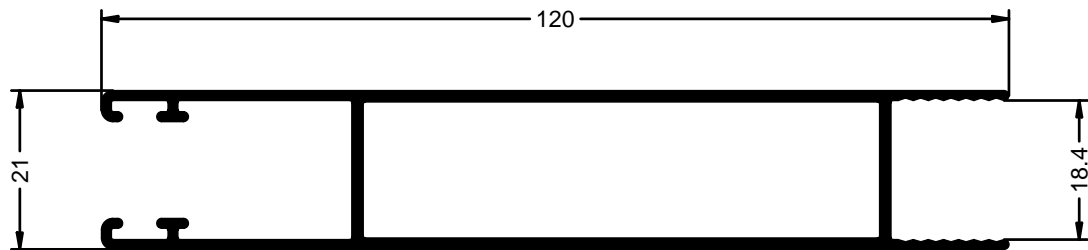

ZÓCALO DE RUEDAS CLIMALIT

Ref: 6070

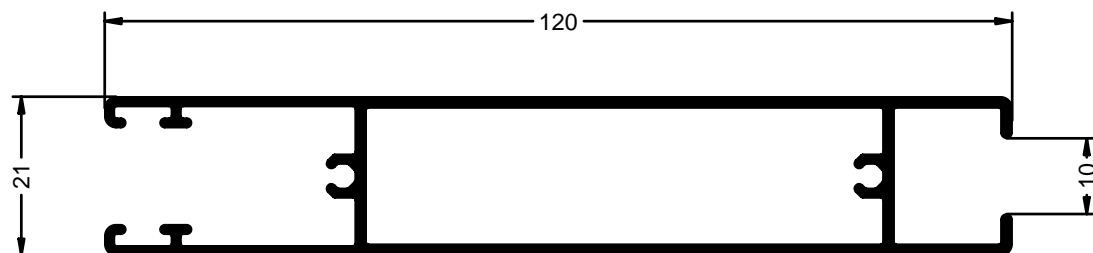

ZÓCALO DE RUEDAS CON TORNILLO

Ref: 6088

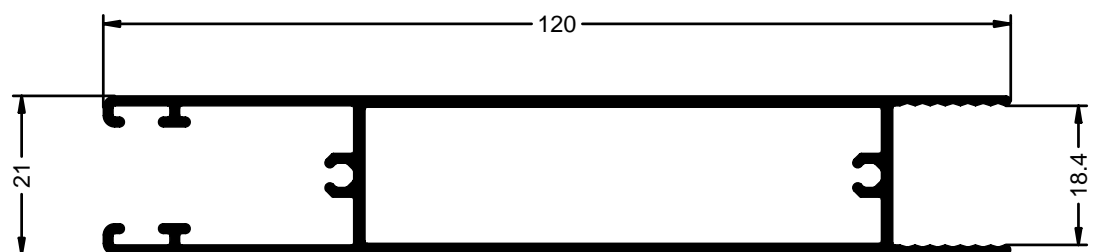

ZÓCALO DE RUEDAS CLIMALIT CON TORNILLO

Ref: 6089

# Serie EUROSTAR 60

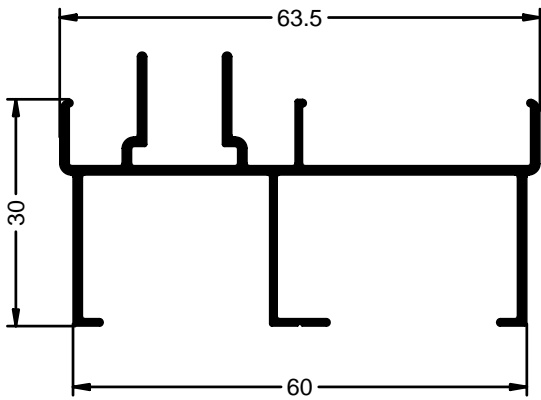

CERCO LATERAL

Ref: 6072

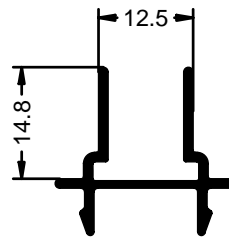

H CUATRO HOJAS

Ref: 6063



EMBELLECEDOR CERCO LATER. Ref: 6064

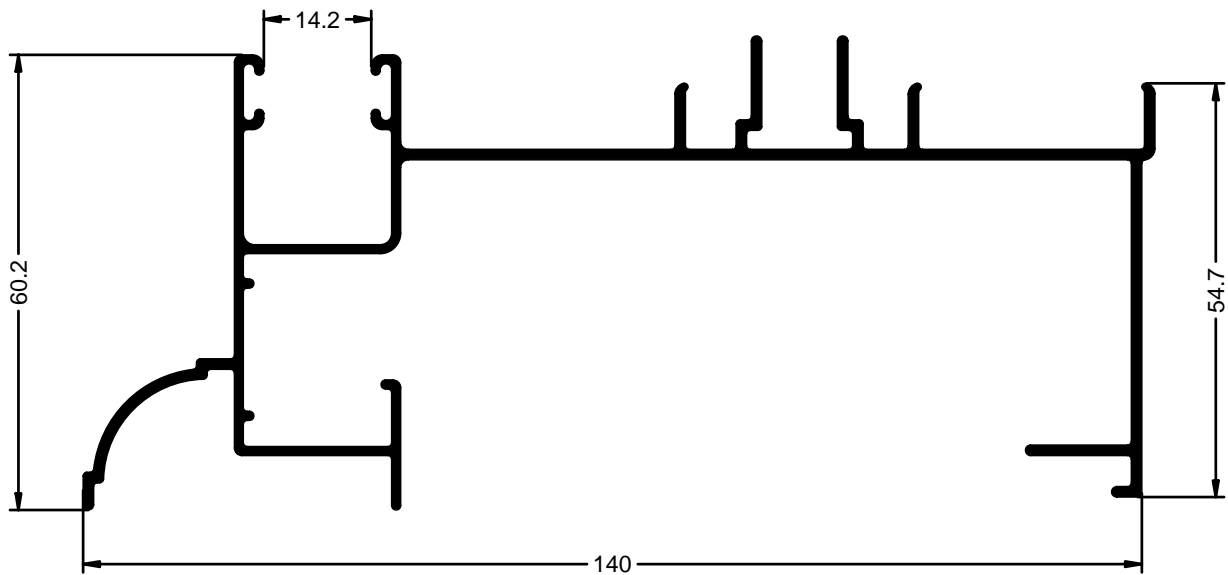

CERCO LATERAL IZQUIERDO (MONOBLOCK)

Ref: 6081

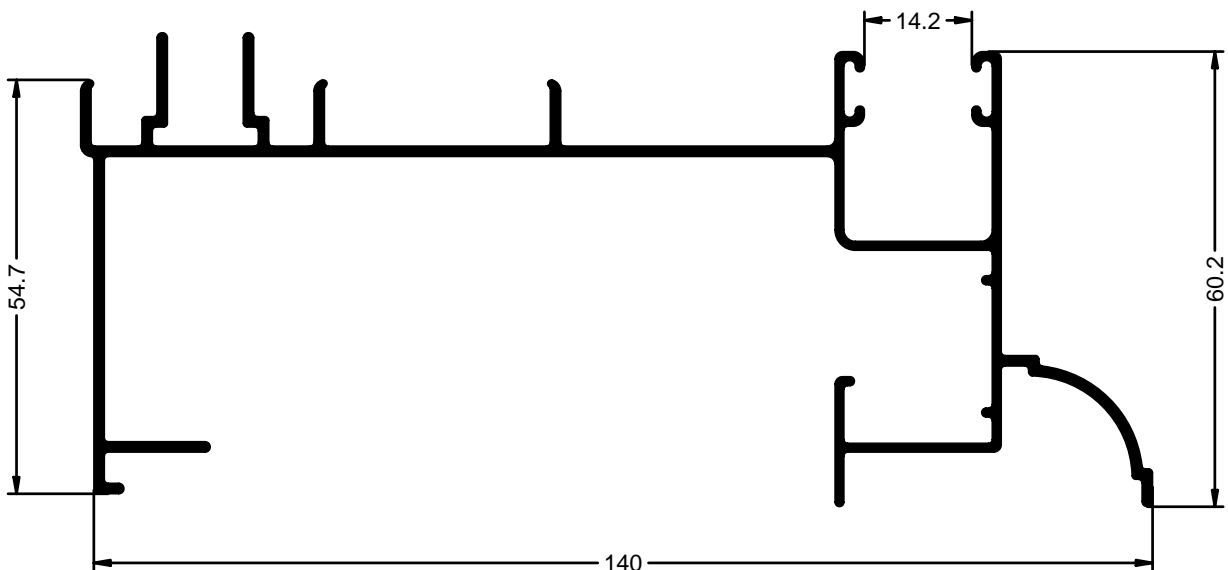

CERCO LATERAL DERECHO (MONOBLOCK)

Ref: 6082

# Serie EUROSTAR 60

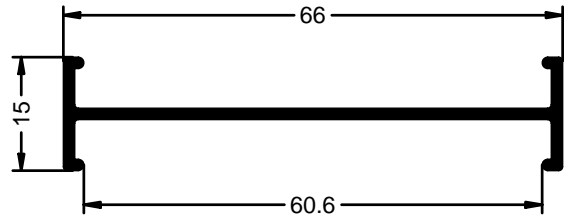
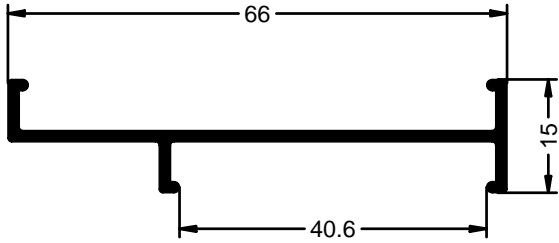

UNIÓN CERCO LATERAL CON PRACTICABLE

Ref: 3386

UNION MARCOS LATERALES

Ref: 3385

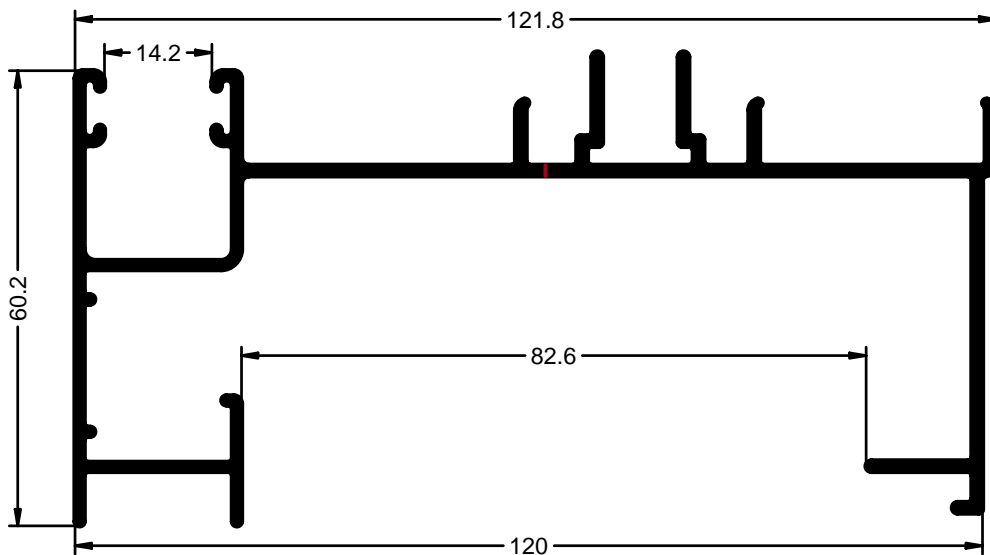

CERCO LATERAL IZQUIERDO (MONOBLOCK)

Ref: 6129

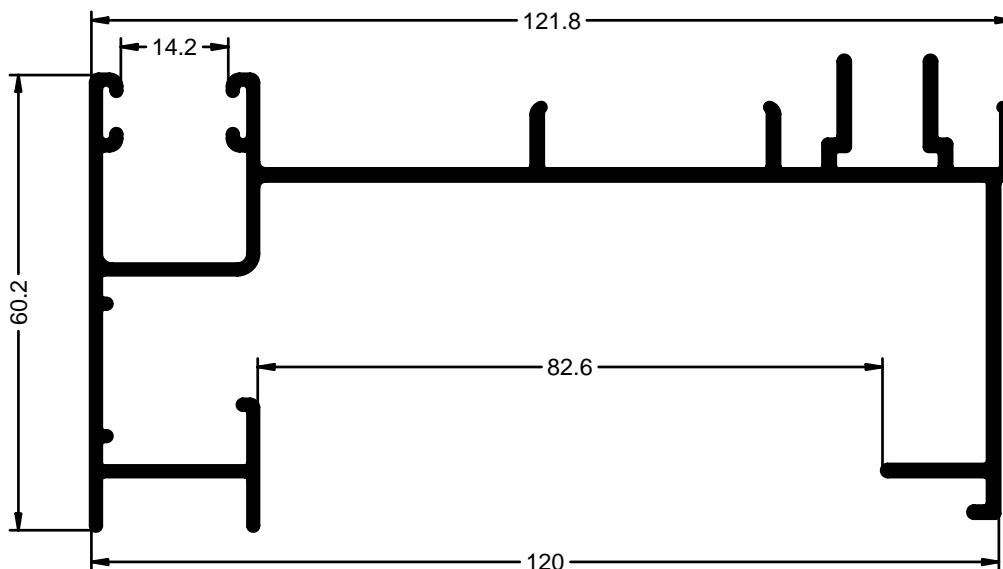

CERCO LATERAL DERECHO (MONOBLOCK)

Ref: 6130

# Serie EUROSTAR 60

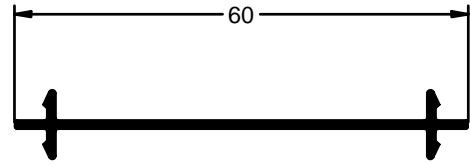
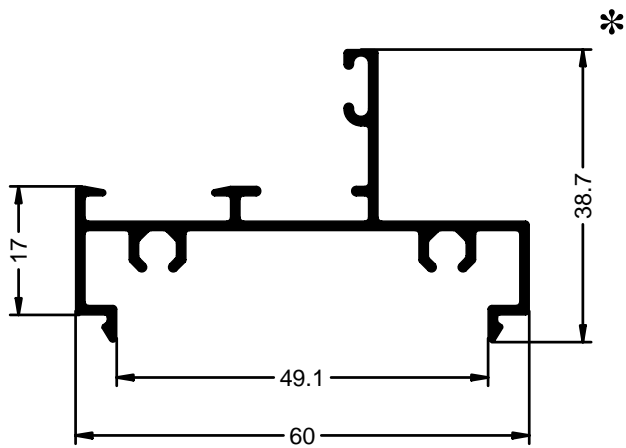

CERCO FIJO

Ref: 6087

UNIÓN DE CERCOS

Ref: 6068

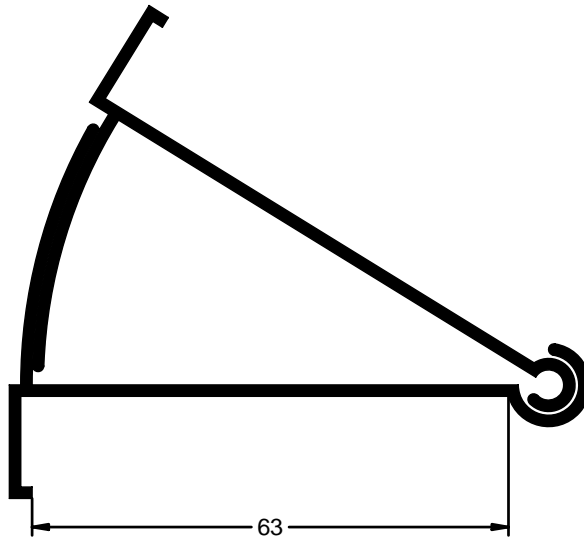

ESQUINERO REGULABLE

Ref: 3377

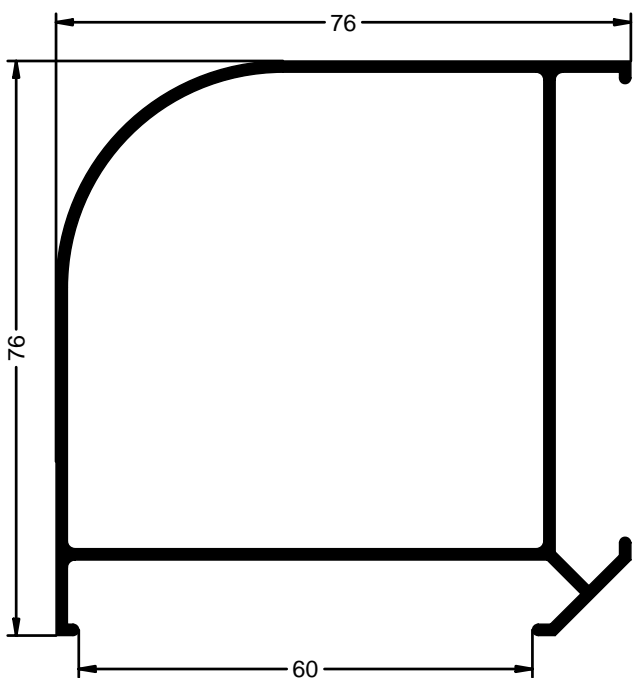

ESQUINERO REDONDO

Ref: 3397

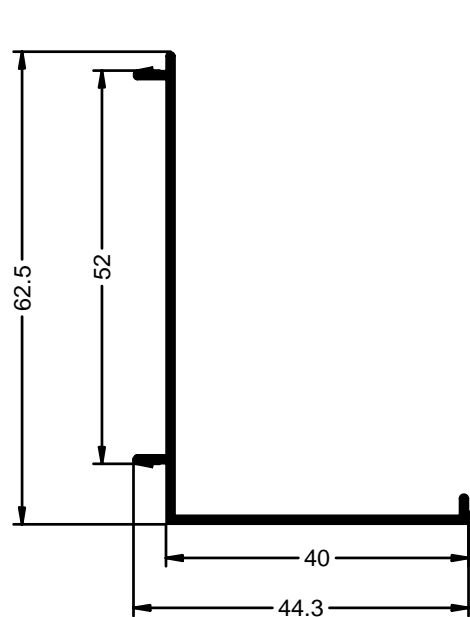

RECERCADO

Ref: 3397

# Serie EUROSTAR 60



			
Tapon pvc tubo 30X15 y alfeizar Ref.-0099	Cierre pulsador con cerradura Ref.-0111	Nudo solape 6085 Ref.-0233	Embelledor junquillo S/ Euro Ref.-0281
			
Valvula desague corredera 100 UD. Ref.-0282	Felpudo 7X6 100 mtr. Ref.-0400	Felpudo 7X7 Film-Seal 100 mtr. Ref.-0402	Felpudo 7X7 100 mtr. Ref.-0408
			
Goma Tapa de Cajón Ref.-0410	Goma cuña grande 100 mtr. Ref.-0412	Goma acristalar ext S/ Euro 100 mtr. Ref.-0450	Goma cuña pequeña 100 mtr. Ref.-0466
			
Asa tirador S/ Euro-Plus Ref.-0663	Cierre Start 60 Ref.-0690	Carcasa superior fija Star 60 Ref.-0691	Carcasa inferior fija Star 60 Ref.-0692
			
Remates embellecedores Star 60 Ref.-0693	Cortavientos superior Star 60/73 Ref.-0694	Cortavientos inferior Star 60 Ref.-0695	Juntas cerco inferior Star 60 Ref.-0696



# Serie EUROSTAR 60



			
Rodamientos Star 60 Ref.-0697	Escuadra solape Ref.-0698	Escuadra fijos Star 60 Ref.-0699	Kit 2 hojas Star 60 rueda fija Ref.-0700
			
Kit 15 ventanas Star 60 rueda fija Ref.-0702	Grapa junquillo redondo 100 und. Ref.-0708	Kit 2 hojas Star 60 rueda regulable Ref.-0709	Kit 15 ventanas Star 60 regulable Ref.-0711
			
Tapeta Star 60 Ref.-0747	Carcasa superior regulable Star 60 Ref.-0754	Carcasa inferior regulable Star 60 Ref.-0755	Util Star 60 Ref.-1028
			
Util cierre embutido Star 60 Ref.-1049	Util compacto Star 60 Ref.-1051	Util cierres Star 60-73 Ref.-1091	

# Serie EUROSTAR 60

## VENTANA CORREDERA 2 HOJAS

CONCEPTO	REF.	CORTE	SIMBOLO	Ud.	MEDIDAS
CERCO SUPERIOR	6050	90°		1	=B-43
CERCO INFERIOR TUBULAR	6052	90°		1	=B-43
CERCO LATERAL	6053	90°		2	=A
* HOJA DE RUEDAS	6059	90°		4	$= (B-120)/2$
HOJA LATERAL	6058	90°		2	=A-42
HOJA CENTRAL	6057	90°		2	=A-42
TAPETA CERCO LATERAL	6064	90°		2	=A-76
* FELPUDO FILM-SEAL 7x7 mm.	0402	90°		6 8	$=A-42$ $= (B-120)/2$
GOMA ACRISTALAR	0412	45°		4 4	$=A-121$ $= (B-165)/2$
CLIMALIT 4 - 12 - 4		90°		2	$=A-121$ $= (B-165)/2$
KIT 2 HOJAS RUEDA FIJA	0700			1	

\* EL DESCUENTO DE LAS REF. 6059 Y 0402 CON ESCUADRA TORNILLO ES:  $= (B-88)/2$

**AVISO:** Las medidas de este cuadro son orientativas

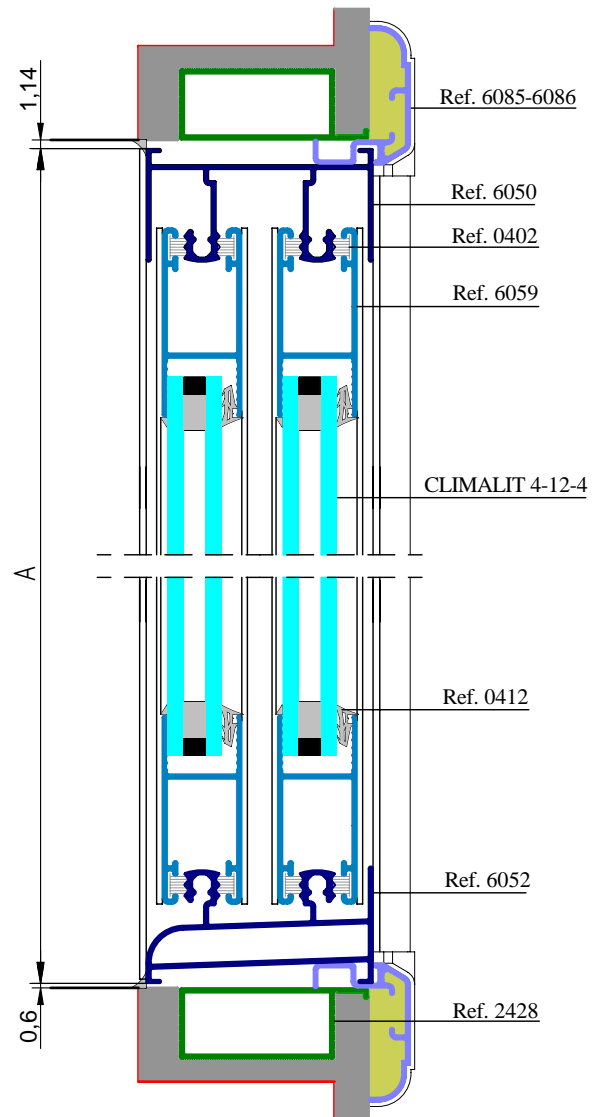

**SECCION VERTICAL**

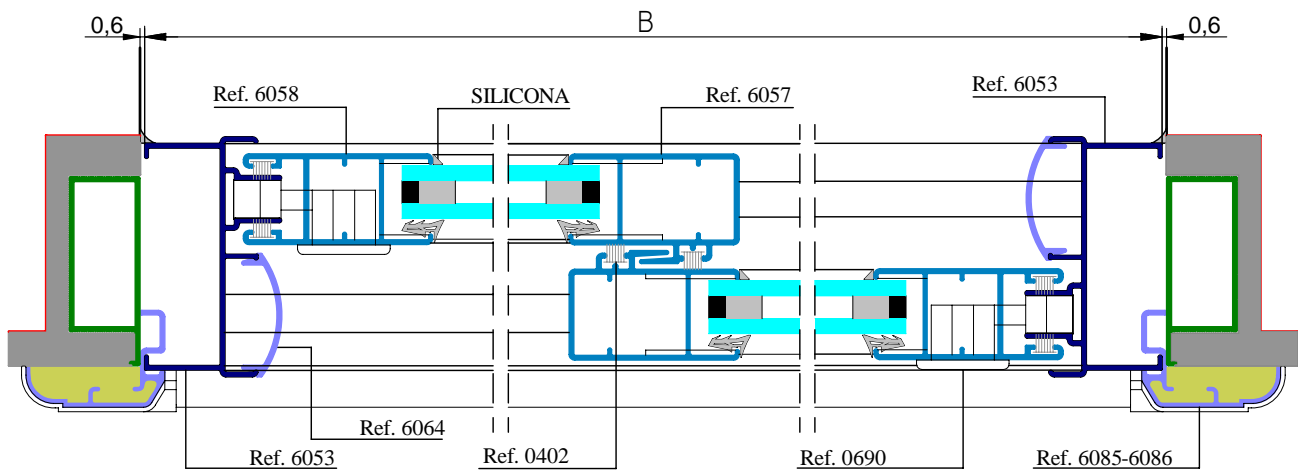

**SECCION HORIZONTAL**

# Serie EUROSTAR 60

## VENTANA CORREDERA 4 HOJAS

CONCEPTO	REF.	CORTE	SIMBOLO	Ud.	MEDIDAS
CERCO SUPERIOR	6050	90°		1	=B-43
CERCO INFERIOR TUBULAR	6052	90°		1	=B-43
CERCO LATERAL	6053	90°		2	=A
* HOJA DE RUEDAS	6059	90°		8	=(B-196)/4
HOJA LATERAL	6058	90°		4	=A-42
HOJA CENTRAL	6057	90°		4	=A-42
COMPLEMENTO 4 HOJAS	6063	90°		1	=A-42
TAPETA CERCO LATERAL	6064	90°		2	=A-76
FELPUDO FILM-SEAL 7x7 mm.	0402	90°		10 16	=A-42 =(B-196)/4
GOMA ACRISTALAR	0412	45°		8 8	=A-121 =(B-284)/4
CLIMALIT 4 - 12 - 4		90°		2	=A-121 =(B-284)/4
KIT 2 HOJAS RUEDA FIJA	0700			2	

\* EL DESCUENTO DE LAS REF. 6059 Y 0402 CON ESCUADRA TORNILLO ES: =(B-125)/4

**AVISO:** Las medidas de este cuadro son orientativas

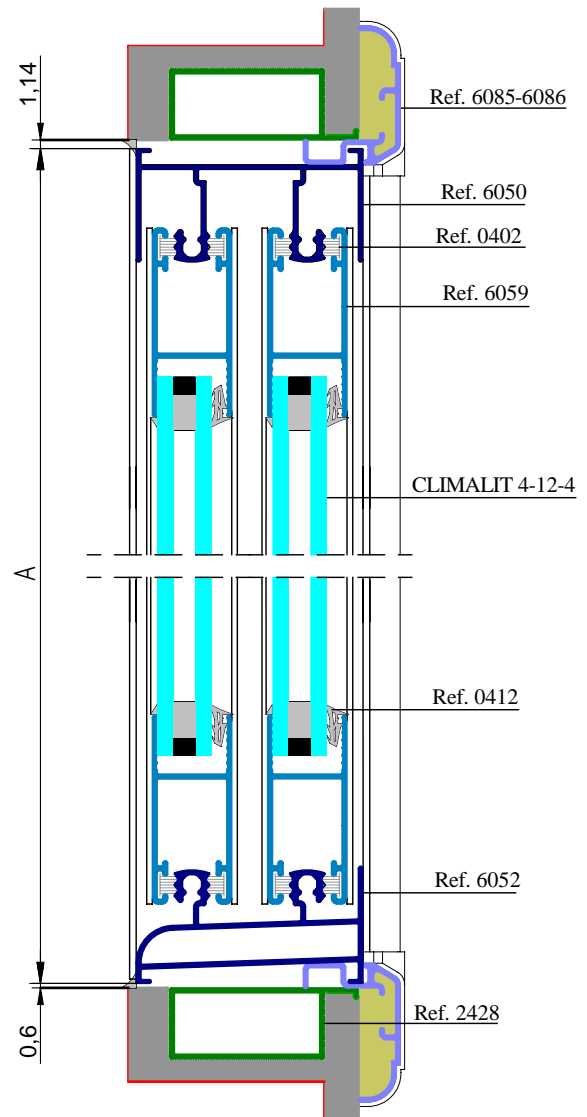

**SECCION VERTICAL**

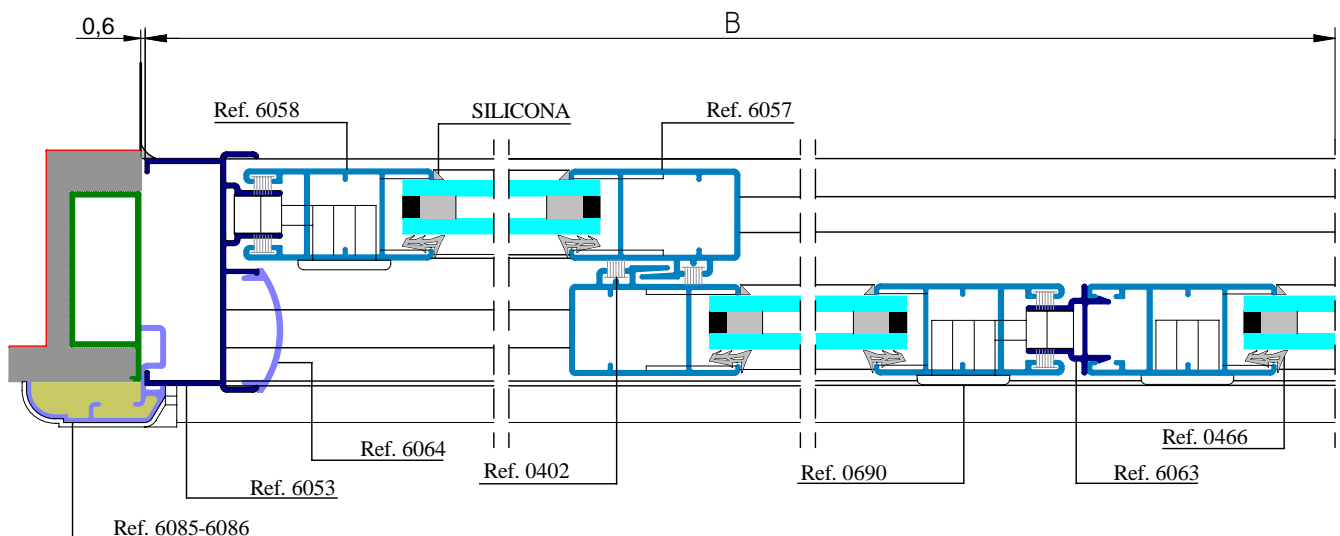

**SECCION HORIZONTAL**

# Serie EUROSTAR 60



## SECCION VERTICAL

VENTANA 2 HOJAS  
SISTEMBLOCK  
CON HOJA DE  
RUEDAS Ref. 6091

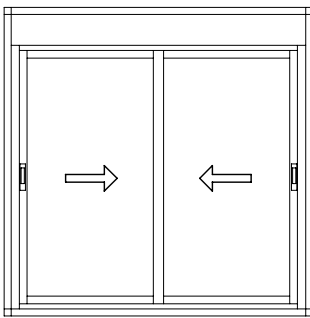

## ALZADO

ESPUMA POLIURETANO  
PARA FIJAR

Ref. 2571

Ref. 0099

SILICONA

## SECCION HORIZONTAL

Ref. 0407

Ref. 6082

Ref. 2464

Ref. 6058

Ref. 6057

Ref. 6081

Ref. 6064

Ref. 0402

Ref. 0690

